

marantz®

Model CC4300 User Guide

Multiple Compact Disc Player

CLASS 1 LASER PRODUCT
KLASSE 1 LASER PRODUKT
I.H.T. IEC 825

COMPACT
disc
DIGITAL AUDIO

ENGLISH

WARRANTY

For warranty information, contact your local Marantz distributor.

RETAIN YOUR PURCHASE RECEIPT

Your purchase receipt is your permanent record of a valuable purchase. It should be kept in a safe place to be referred to as necessary for insurance purposes or when corresponding with Marantz.

IMPORTANT

When seeking warranty service, it is the responsibility of the consumer to establish proof and date of purchase. Your purchase receipt or invoice is adequate for such proof.

FOR U.K. ONLY

This undertaking is in addition to a consumer's statutory rights and does not affect those rights in any way.

FRANÇAIS

GARANTIE

Pour des informations sur la garantie, contacter le distributeur local Marantz.

CONSERVER L'ATTESTATION D'ACHAT

L'attestation d'achat est la preuve permanente d'un achat de valeur. La conserver en lieu sûr pour s'y reporter aux fins d'obtention d'une couverture d'assurance ou dans le cadre de correspondances avec Marantz.

IMPORTANT

Pour l'obtention d'un service couvert par la garantie, il incombe au client d'établir la preuve de l'achat et d'en corroborer la date. Le reçu ou la facture constituent des preuves suffisantes.

DEUTSCH

GARANTIE

Bei Garantiefragen wenden Sie sich bitte an Ihren Marantz-Händler.

HEBEN SIE IHRE QUITTING GUT AUF

Die Quittung dient Ihnen als bleibende Unterlage für Ihren wertvollen Einkauf. Das Aufbewahren der Quittung ist wichtig, da die darin enthaltenen Angaben für Versicherungszwecke oder bei Korrespondenz mit Marantz angeführt werden müssen.

WICHTIG!

Bei Garantiefragen muß der Kunde eine Kaufunterlage mit Kaufdatum vorlegen. Ihren Quittung oder Rechnung ist als Unterlage ausreichend.

NEDERLANDS

GARANTIE

Voor inlichtingen omtrent garantie dient u zich tot uw plaatselijke Marantz.

UW KWITANTIE, KASSABON E.D. BEWAREN

Uw kwitantie, kassabon e.d. vormen uw bewijs van aankoop van een waardevol artikel en dienen op een veilige plaats bewaard te worden voor evt. verwijzing bijv. in verbod met verzekering of bij correspondentie met Marantz.

BELANGRIJK

Bij een evt. beroep op de garantie is het de verantwoordelijkheid van de consument een gedateerd bewijs van aankoop te tonen. Uw kassabon of factuur zijn voldoende bewijs.

ESPAÑOL

GARANTIA

Para obtener información acerca de la garantía póngase en contacto con su distribuidor Marantz.

GUARDE SU RECIBO DE COMPRA

Su recibo de compra es su prueba permanente de haber adquirido un aparato de valor. Este recibo deberá guardarlo en un lugar seguro y utilizarlo como referencia cuando tenga que hacer uso del seguro o se ponga en contacto con Marantz.

IMPORTANTE

Quando solicite el servicio otorgado por la garantía el usuario tiene la responsabilidad de demostrar cuándo efectuó la compra. En este caso, su recibo de compra será la prueba apropiada.

ITALIANO

GARANZIA

L'apparecchio è coperto da una garanzia di buon funzionamento della durata di un anno, o del periodo previsto dalla legge, a partire dalla data di acquisto comprovata da un documento attestante il nominativo del Rivenditore e la data di vendita. La garanzia sarà prestata con la sostituzione o la riparazione gratuita delle parti difettose.

Non sono coperti da garanzia difetti derivanti da uso improprio, errata installazione, manutenzione effettuata da personale non autorizzato o, comunque, da circostanze che non possano riferirsi a difetti di funzionamento dell'apparecchio. Sono inoltre esclusi dalla garanzia gli interventi inerenti l'installazione e l'allacciamento agli impianti di alimentazione.

Gli apparecchi verranno riparati presso i nostri Centri di Assistenza Autorizzati. Le spese ed i rischi di trasporto sono a carico del cliente.

La casa costruttrice declina ogni responsabilità per danni diretti o indiretti provocati dalla inosservanza delle prescrizioni di installazione, uso e manutenzione dettagliate nel presente manuale o per guasti dovuti ad uso continuato a fini professionali.

PORTUGUÊS

GARANTIA

Para informações sobre a garantia, contactar o distribuidor Marantz local.

GUARDAR O RECIBO DE COMPRA

O recibo é o registo permanente da compra que fez. Deve ser guardado num local seguro, para ser apresentado em questões relacionadas com o seguro ou para quando tiver de contactar a Marantz.

IMPORTANTE

Quando procurar assistência técnica ao abrigo da garantia, é da responsabilidade do consumidor estabelecer a prova e data de compra. O recibo é prova adequada.

SVENSKA

GARANTI

För information om garantin, kontakta Marantz lokalt.

SPAR KVITTOT

Kvittot är ett inköpsbevis på en värdefull vara. Det skall förvaras säkert och hänvisas till vid försäkringsfall eller vidkorrespondens mod Marantz.

VIKTIGT

Fö att garantin skall gälla är det kundens sak att framställa bevis och datum om köpet. Kvitto eller faktura är tillräckligt bevis för detta.

DANSK

GARANTI

Henvend dem til Deres MARANTZ-forhandler angående information om garantien.

GEM DERES KVITTERING

Deres købskvittering er Deres varige bevis på et dyrt køb. Den bør gemmes godt og anvendes som bevis, hvis De vil tegne en forsikring, eller hvis De kommunikerer med Marantz.

VIGTIGT

Det påhviler forbrugeren at skaffe bevis for købet og købsdatoen, hvis han eller hun ønsker garantiservice. Deres købskvittering eller faktura er et fuldgældigt bevis herpå.

ENGLISH:
CAUTION – USE OF CONTROLS OR ADJUSTMENTS OR PERFORMANCE OF PROCEDURES OTHER THAN THOSE SPECIFIED HEREIN MAY RESULT IN HAZARDOUS RADIATION EXPOSURE.

FINNISH:
VAROITUS! Laitteen käyttäminen muulla kuin tässä käyttöohjeessa mainitulla tavalla saattaa altistaa käyttäjän turvallisuusluokan 1 ylittävälle näkymättömälle lasersäteilylle.

SWEDISH:
WARNING! Om apparaten används på annat sätt än vad som beskrivs i denna bruksanvisning kan användaren utsättas för osynlig laserstrålning som överskrider gränsen för laserklass 1 .

WARNINGS FOR LASER RADIATION

CAUTION : INVISIBLE LASER RADIATION WHEN OPEN. DO NOT STARE INTO BEAM.

DANGER : INVISIBLE LASER RADIATION WHEN OPEN. AVOID DIRECT EXPOSURE TO BEAM.

VARO! : AVATTAESSA JA SUOJALUKITUS OHITETTAESSA OLET ALTTIINANAKYMÄTTÖMÄALLE LASERSÄTEILYLLE. ÄLÄ KATSO SÄTEESEEN.

WARNING! : OSYNLIG LASERSTRÅLNING NÄR DENNA DEL ÄR ÖPPNAD OCH SPÄRREN ÄR URKOPPLAD. BETRAKTA EJ STRALEN.

Contents

General Information	2
Foreword.....	2
Unpacking.....	2
For Your Safety.....	2
Compact Discs.....	3
Placement.....	3
Functional Overview	4
Front Panel Controls.....	4
Rear Panel Controls.....	6
Remote Control Unit (RC4300CC).....	7
Connections.....	9
Connecting other Audio Equipment.....	9
Connecting the Remote Control.....	10
Operations	11
Playing CDs.....	11
Changing Discs during Play.....	12
Skip and Search Play.....	12
Playing Tracks in Random Sequence (Random Play).....	13
Playing the First 10 Seconds of Each Track (Introsan Play).....	13
Repeat Play.....	14
Playing Tracks in Any Sequence (Programmed Play).....	14
Editing for Recording.....	18
Deleted Play.....	22
Selecting a Brightness of the Display.....	24
Selecting a Time Display.....	25
Using the Headphones.....	25
External Control (Serial Interface) RS-232C.....	26
Troubleshooting	28
Specifications	29

General Information

Foreword

This section must be read carefully before any connection is made to the mains supply.

WARNINGS

Do not expose the equipment to rain or moisture.
Do not remove the cover from the equipment.
Do not insert anything into the equipment through the ventilation holes.
Do not handle the mains lead with wet hands.

CE marking (only EU version)

CE This product is in conformity with the EMC directive and low-voltage directive.

Equipment mains working system

Your Marantz product complies with the household power and safety requirements in your area.
“N1” Version product can be powered by 230 V AC only.

IMPORTANT: (FOR/UK. version only)

This apparatus is fitted with an approved moulded 13 Amp plug. To change a fuse in this type of plug proceed as follows:

1. Remove fuse cover and fuse.
2. Fix new fuse which should be a BS1362 5A, A.S.T.A. or BSI approved type.
3. Refit the fuse cover.

If the fitted plug is not suitable for your socket outlets, it should be cut off and an appropriate plug fitted in its place. If the mains plug contains a fuse, this should have a value of 5A. If a plug without a fuse is used, the fuse at the distribution board should not be greater than 5A.

Note :

The severed plug must be destroyed to avoid a possible shock hazard should it be inserted into a 13A socket elsewhere.

HOW TO CONNECT A PLUG

The wires in the mains lead are colored in accordance with the following code:

BLUE—“NEUTRAL” (“N”)

BROWN—“LIVE” (“L”)

1. The BLUE wire must be connected to the terminal which is marked with the letter “N” or colored BLACK.
2. The BROWN wire must be connected to the terminal which is marked with the letter “L” or colored RED.
3. Do not connect either wires to the earth terminal in the plug which is marked by the letter “E” or by the safety earth symbol or colored green or green-and-yellow.

Before replacing the plug cover, make certain that the cord grip is clamped over the sheath of the lead — not simply over the two wires.

Copyright

Recording and playback of some material may require permission. For further information refer to the following:

- Copyright Act 1956
- Dramatic and Musical Performers Act 1958
- Performers Protection Acts 1963 and 1972
- Any subsequent statutory enactments and orders

Unpacking

First check the contents of the packaging. It should contain the following:

- CD-Player CC4300
- Remote control unit (RC4300CC)
- Batteries (AAA size) x 2
- Audio cables (2 - with red and white plugs)
- Remote control cable (with orange plugs)
- Instructions
- Guarantee

If one of these components is missing, please inform your supplier immediately. Save the packaging material it may come in handy if you move the appliance.

For Your Safety

Units shipped to the U.S.A. and Canada are designed for operation on 120 V AC only.

Safety precaution with use of a polarized AC plug. However, some products may be supplied with a nonpolarized plug.

CAUTION :

To prevent electric shock, match wide blade of plug to wide slot, fully insert.

ATTENTION :

Pour éviter les choc électriques, introduire la lame la plug large de la borne correspondante de la prise et pousse jusqu'au fond.

Compact Discs

The glossy side shining like a rainbow is the front side of the disc, and the side on which the label is printed is the back.

Unlike conventional turntables for playing analog discs, the CC4300 reads the information recorded on the disc from underneath without contacting it using a beam of laser light. Therefore, the performance of a compact disc will not degrade like conventional analog records.

Handle discs carefully so as not to damage or scratch the front side.

To protect the disc, avoid placing it in the following locations:

- In direct sunlight or near a source of heat like a heater.
- In a place which is damp or dirty.
- In a place which could be exposed to rain, such as near a window.

Always keep the disc surface clean.

Up to six billion data units are recorded on the front side of the disc. When cleaning the disc surface, always be sure to use a special compact disc cleaner and wipe as shown below.

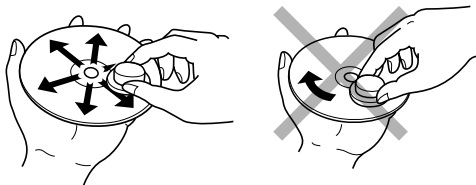

- Do not use conventional record cleaner for analog records, as this will adversely affect the disc surface. Store discs properly by placing them in their disc cases.
- Do not attach a piece of paper or sticker on the label side of disc. When a disc has a piece of plastic tape or rental CD label with paste protruded from the edge or when a disc has a trace of such a sticky object, do not attempt to play the disc. If such a disc is played on the CD player, impossibility of taking out the disc or other malfunction may result.

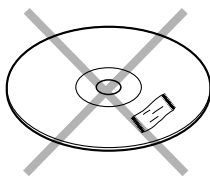

- Write only on the printed side of a CD-R or CD-RW, and only with a soft felt-tipped pen.
- Do not use a disc with a special shape. Do not attempt to play a disc with a special shape such as a heart-shaped disc or octagonal disc. Otherwise the equipment malfunction may result.

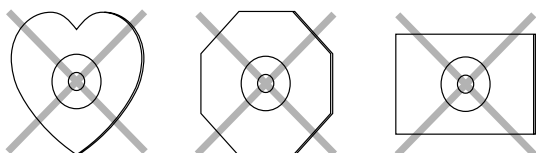

❖ Playing CD-RW discs

This unit can play back the CD-RW (ReWritable) discs as well as ordinary music CD and CD-R (Recordable) discs.

- The CD-R and CD-RW discs should contain properly-recorded TOC information so that they can be played back. With the CD recorder system, writing the TOC information in a disc is referred to as finalizing the disc. A disc cannot be recognized as a CD disc and played back unless it has been finalized properly. For details, please read the instruction manual provided with a CD recorder.
- TOC stands for Table Of Contents and contains information such as the total number of tracks and total playing time of the disc.
- This unit can play only the discs recorded in the CD-DA format designed for music reproduction. Do not attempt to play a disc containing other data, such as a CD-ROM for PCs, on this unit.
- As the playback of a CD-RW disc necessitates partial change of the player setup, it may take longer time for reading the TOC information than when a music CD or CD-R disc is played.
- A few CD-RW discs may not be played in some reason. Please use another disc to play.

Placement

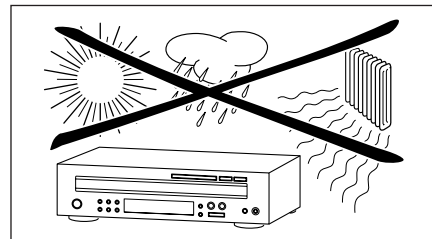

- Place the CD player on a firm, flat surface.
- Keep away from domestic heating equipment and direct sunlight.
- In a cabinet, allow about 2 inches of free space all around the player for adequate ventilation.
- If the CD player cannot read CDs correctly, use a commonly-available cleaning CD to clean the lens before taking the CD-player to be repaired. Other cleaning methods may destroy the lens. Always keep the tray closed to avoid dust on the lens.
- When it is moved from a cold to a warm environment, allow the CD player to acclimatize for at least 2 hours in order to avoid damage. When suddenly placed in a warm environment, the lens may cloud over. Playing an CD will not be possible then. Wait until the moisture evaporates.
- Do not use the CD player under extremely damp conditions.
- Do not expose discs to direct sunlight, high humidity or high temperature for a long time.

Attention!

If the appliance is not used or operated in accordance with the instructions, this may result in exposure to dangerous radiation or other risks.

Only authorized technicians are allowed to open the appliance casing or to perform repairs or maintenance.

Functional Overview

Front Panel Controls

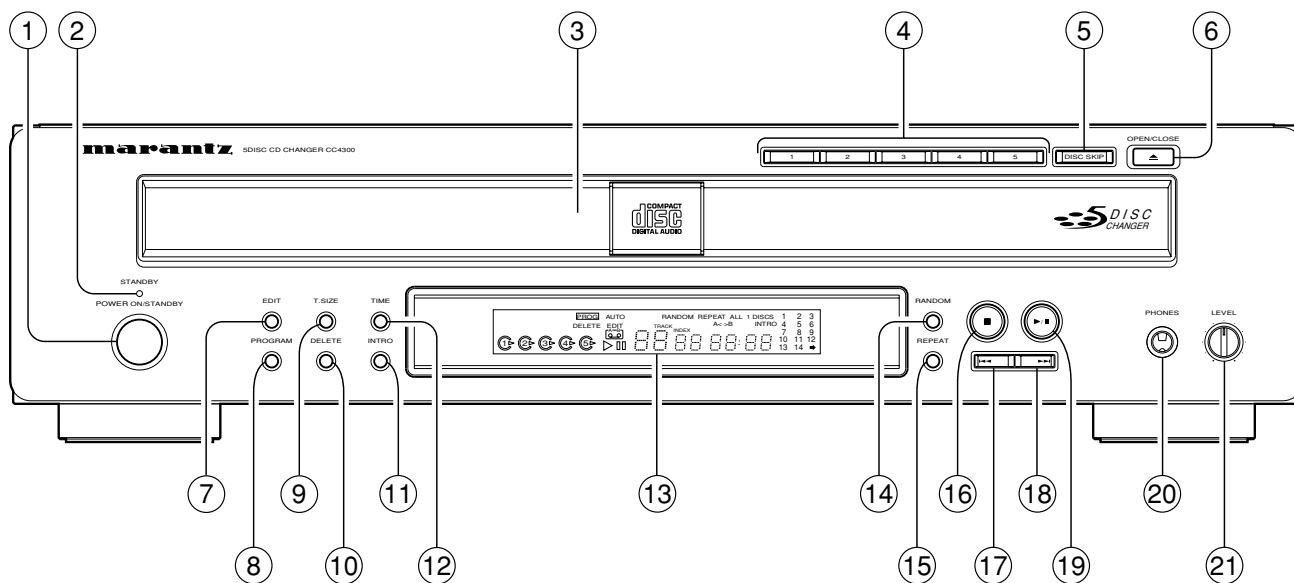

① POWER ON/STANDBY button

Press this switch to turn the power on and press again to turn to stand by.

② STANDBY indicator

Lights up red when the CD player is in Stand-by mode.

③ Disc tray

Load a compact disc on the disc tray.

④ Disc selector buttons

Use these buttons to select the disc to be played.

⑤ DISC SKIP button

For loading or unloading discs, press this button to rotate clockwise to the next disc position.

⑥ OPEN/CLOSE button (▲)

Press this button to open or close the disc tray.

⑦ EDIT button

Press this button to edit the tracks to be recorded onto the tape.

⑧ PROGRAM button

Press this button to program your favorite tracks, disc or review the programmed selections.

⑨ T. SIZE (Tape size) button

Use this button to select the tape length in edit recording.

⑩ DELETE button

Press this button to delete the undesired tracks, discs or review the deleted selections.

⑪ INTRO (Introscan) button

Press this button to play the first 10 seconds of each track on CDs.

⑫ TIME button

Press this button to display the elapsed or remaining playing time of the current track or remaining playing time of the disc.

⑬ Fluorescent display

For details, refer to the next page.

⑭ RANDOM button

Press this button to play tracks on CDs in random sequence.

⑮ REPEAT button

Press this button to play a track, a disc or all discs repeatedly.

⑯ ■ (Stop/Clear) button

Press this button to stop play, clear the programmed selections or recover the deleted selections.

⑰ ◀ (Backward skip/Search) button

- Press this button to replay from the beginning of the current track or return to a previous track.
- Press and hold down this button to search for a specific passage in fast backward.

18 ►► (Forward skip/Search) button

- Press this button to play from the beginning of a next track.
- Press and hold down this button to search for a specific passage in fast forward.

19 ► / II (Play/Pause) button

- Press this button to start playing in the stop or pause mode.
- Press this button to interrupt play temporarily and press again to restart play.

20 PHONES jack

Stereo headphones can be plugged into this jack for private listening.

21 LEVEL knob

Turning the control clockwise increases the headphone level. Turning the control counterclockwise decreases the headphone level.

❖ Fluorescent Display

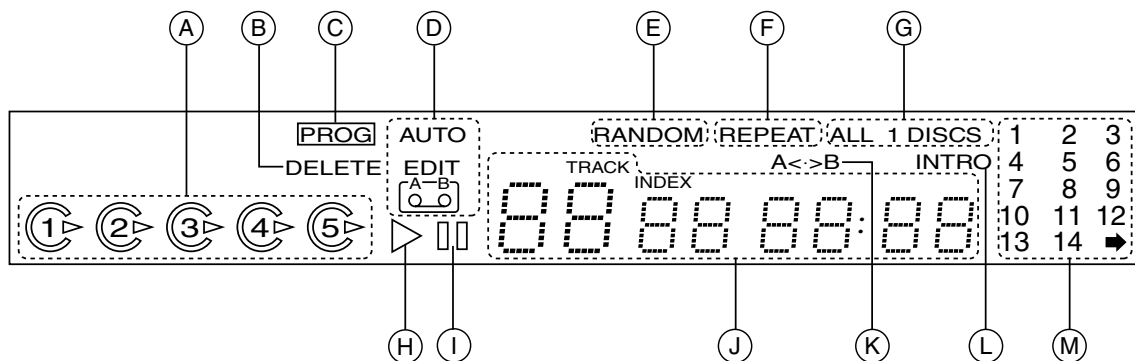

A Disc number display

B DELETE indicator

C PROGRAM indicator

D EDIT display

E RANDOM PLAY indicator

F REPEAT indicator

G Indicators for Repeat, Introskan and Random play mode

H PLAY indicator

I PAUSE indicator

J Track number and Time display

K REPEAT A<->B indicator

L INTROSCAN indicator

M Music calendar display

Rear Panel Controls

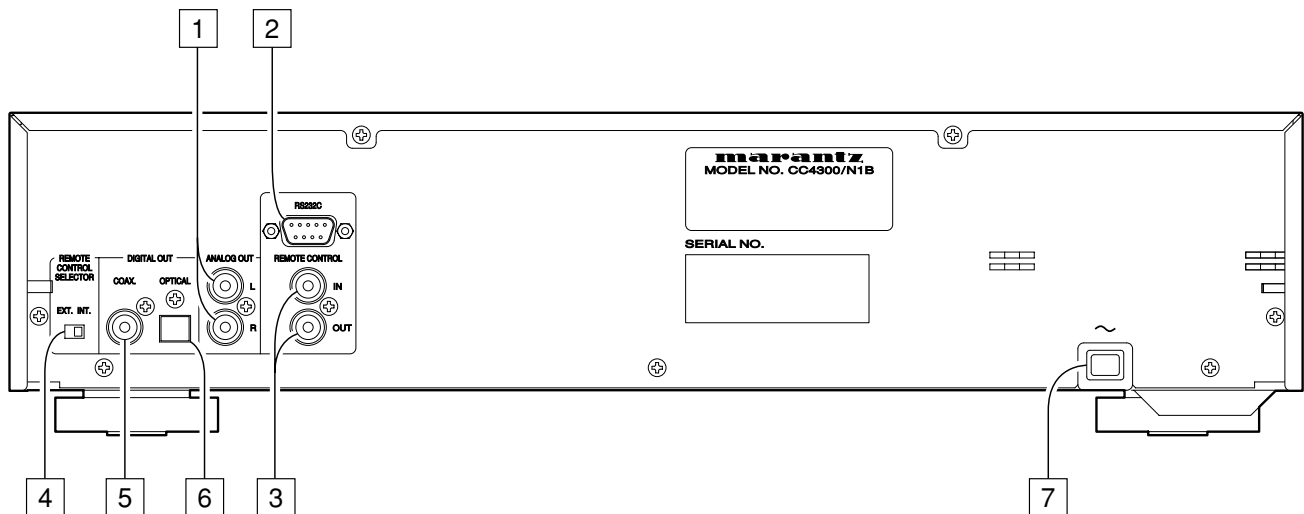

1 ANALOG output jacks

Connect these jacks to the CD(or AUX) input jacks of your amplifier or receiver.

2 RS232C

The RS232C port is to be used in conjunction with an external controller to control the operation of the CD player by using an external device. (See also page 26.)

3 REMOTE CONTROL IN/OUT jacks

By connecting this CD player to another Marantz audio component using a D-BUS remote control cable, you can operate the components remotely as a single system.

- When connecting to a component with a remote sensor, connect the REMOTE CONTROL IN jack of this unit to the REMOTE CONTROL OUT jack of the component with the remote sensor.
- When connecting to a component which is not equipped with a remote sensor, connect the component to the REMOTE CONTROL OUT jack of this unit. For the D-BUS cable connection, use supplied remote control cable or a commercially available RCA-type pin lead.
- By connecting this CD player to a Marantz auto reverse cassette deck (such as the SD4050), automatic recording from the CD player to the cassette deck can be carried out.

4 REMOTE CONTROL SELECTOR switch

When using this unit independently, set this switch to INTERNAL. When using this unit in a system incorporating a Marantz tuner or timer equipped with a remote sensor, set the switch to EXTERNAL.

Note :

- Always set this switch to INTERNAL unless the unit is connected with other MARANTZ equipment through a system connection. When this switch is set to EXTERNAL, the main unit cannot be controlled from the provided remote control unit.

5 DIGITAL output (COAX.) jack

- Connect this jack to the COAXIAL DIGITAL input jack of amplifier or receiver to enjoy live digital sound.
- You can record digital sound by connecting the COAXIAL DIGITAL INPUT jack of MD deck or CDR recorder to this jack.

6 DIGITAL output (OPTICAL) jack

- Connect this jack to the OPTICAL DIGITAL input jack of amplifier or receiver to enjoy live digital sound.
- You can record digital sound by connecting the OPTICAL DIGITAL INPUT jack of MD deck or CDR recorder to this jack.
- Not all of the commercially-available optical fiber cords can be used for audio equipment. If there is an optical fiber cord which cannot be connected to your audio equipments, consult your dealer or nearest service organization.

7 AC input cord

Plug this cord into a wall AC outlet or the switched AC outlet of amplifier or receiver.

Remote Control Unit (RC4300CC)

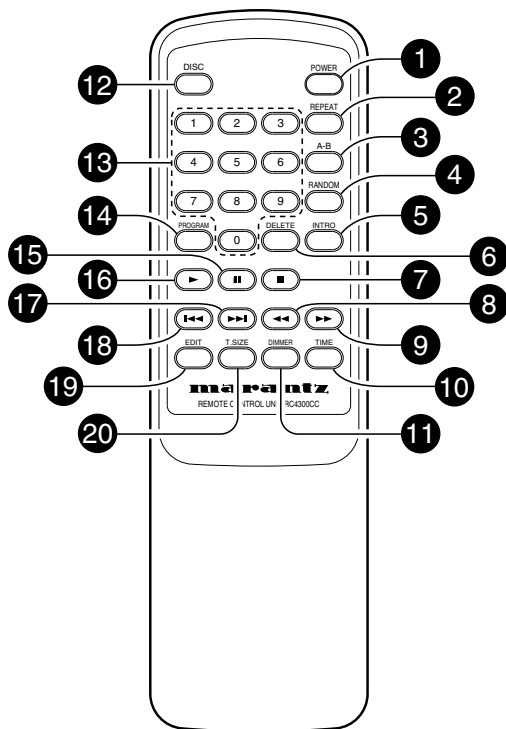

1 POWER button

Press this button to turn the power on and press again to turn to stand by.

2 REPEAT button

Press this button to play a track, a disc or all discs repeatedly.

3 REPEAT A<->B button

Press this button to play a specific passage repeatedly.

4 RANDOM button

Press this button to play tracks on CDs in random sequence.

5 INTRO (Introsan) button

Press this button to play the first 10 seconds of each track on CDs.

6 DELETE button

Press this button to delete the undesired tracks, discs or review the deleted selections.

7 ■ (Stop/Clear) button

Press this button to stop play, clear the programmed selections or recover the deleted selections.

8 ◀◀ (Search) button

Press and hold down this button to search for a specific passage in fast backward.

9 ▶▶ (Search) button

Press and hold down this button to search for a specific passage in fast forward.

10 TIME button

Press this button to display the elapsed or remaining playing time of the current track or remaining playing time of the disc.

11 DIMMER button

Press this button to change the brightness of the display.

12 DISC button

When selecting a disc with this button, press this first and then the desired disc number(1~5) on the numeric buttons within 2 seconds.

13 NUMERIC buttons

Press the corresponding button when selecting tracks or discs for play, programming or deleting, then the selected track is played, programmed or deleted directly without use of the PLAY, PROGRAM/REVIEW or DELETE/REVIEW button.

- When selecting a two digit number, the second digit should be pressed within 2 seconds after the first digit has been pressed

14 PROGRAM button

Press this button to program your favorite tracks, disc or review the programmed selections.

15 || (Pause) button

Press this button to interrupt play temporarily and press again to restart play.

16 ▶ (Play) button

- Press this button to start play in the stop or pause mode.

17 ▶▶ (Forward skip) button

- Press this button to play from the beginning of a next track.

18 ◀◀ (Backward skip) button

- Press this button to replay from the beginning of the current track or return to a previous track.

19 EDIT button

Press this button to edit the tracks to be recorded onto the tape.

20 T. SIZE (Tape size) button

Use this button to select the tape length in edit recording.

❖ Operation of Remote Control Unit

1. Remote control

The distance between the transmitter of the remote control unit and the IR SENSOR of the CC4300 should be less than about 5 meters. If the transmitter is pointed to a direction other than the IR SENSOR or if there is an obstacle between them, remote control may not be possible.

Remote-controllable range

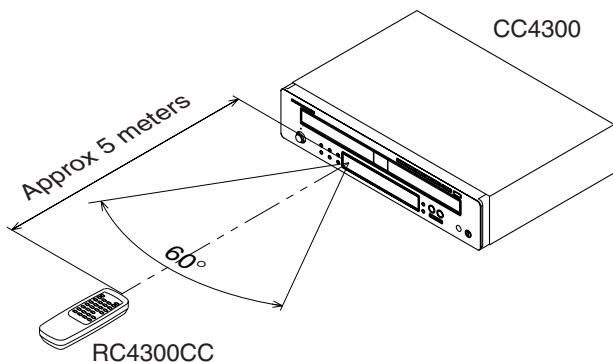

2. Loading batteries

The life of the batteries used with the remote control unit is about 6 months with normal use. Also be sure to replace batteries earlier when you notice that they are getting weak.

1. Remove the back cover.

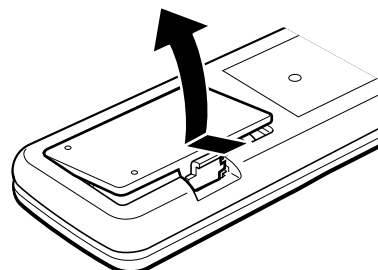

Note :

- Remove the batteries when they are not used for a long time.
- Do not use the rechargeable batteries(Ni-Cd type).

2. Insert the new batteries (AAA size) with correct (+) and (-) polarity.

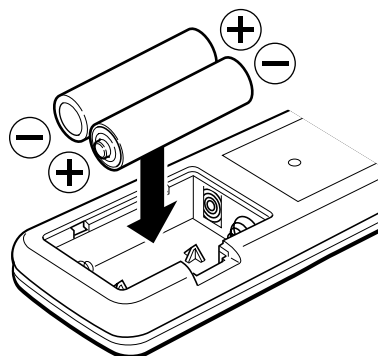

3. Close until it clicks.

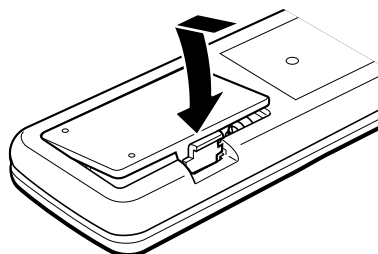

Connections

Precautions concerning connections :

- Do not plug the AC input cord into the AC outlet when plugging and unplugging connection cords.
- Be sure to connect the white plugs to the L(Left) and the red plugs to the R(Right) jacks when making connections with the supplied cords.
- Plug the optical digital cable in securely, as far as it will go.
- Refer to the connecting diagram in the operating instructions of AMPLIFIER/RECEIVER.

Connecting other Audio Equipment

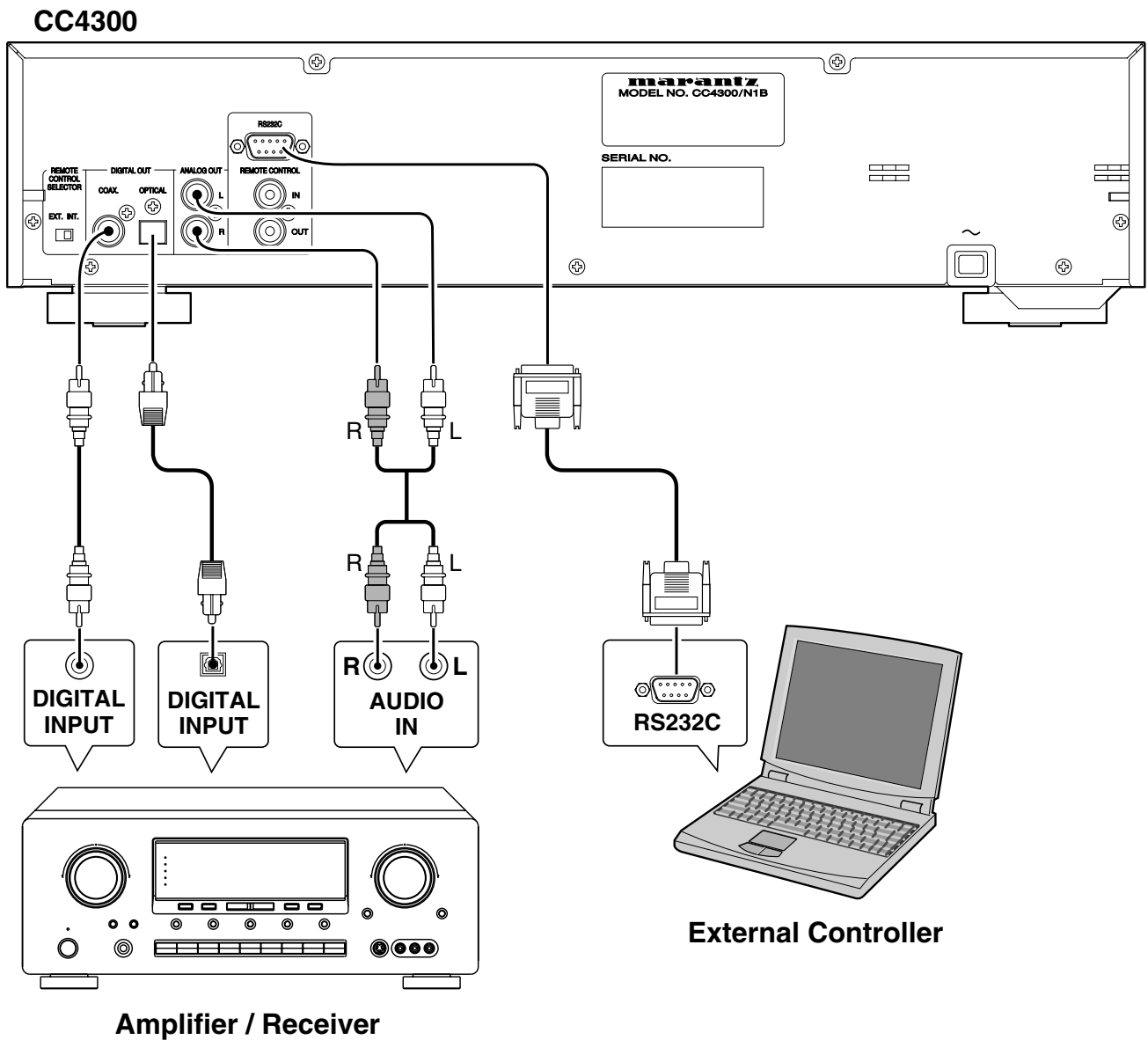

Connecting the Remote Control

English

CC4300

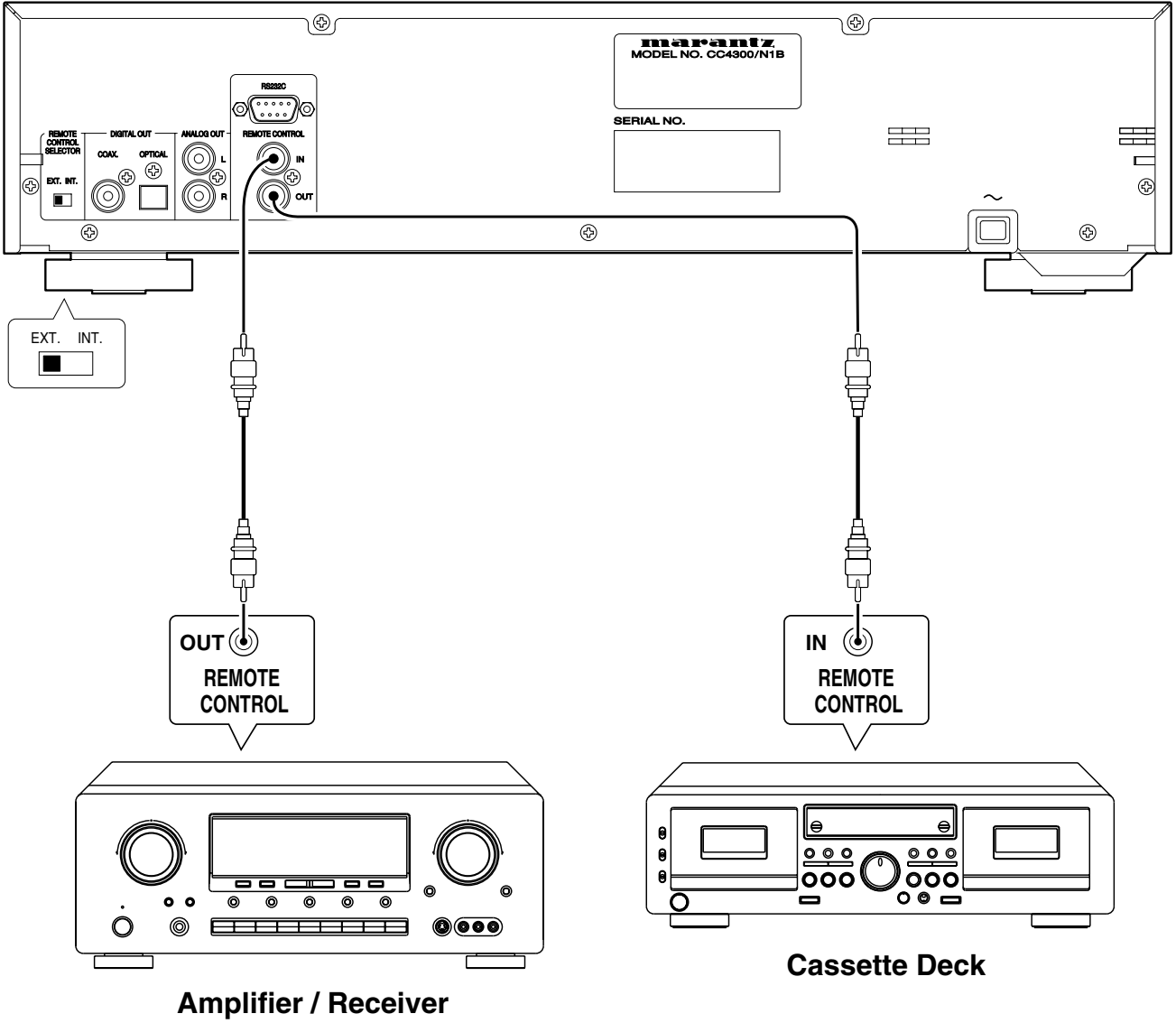

Operations

Playing CDs

1. Press the **POWER ON/STANDBY** button on the unit or the **POWER** button on the remote control to turn on the power.

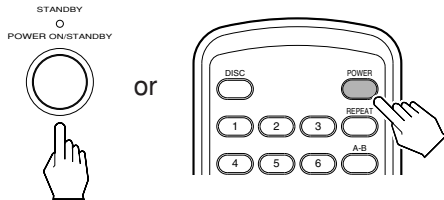

- Each time the **POWER ON/STANDBY** (or **POWER**) button is pressed, this unit is turned on or off.

2. Press the **OPEN/CLOSE** button on the unit to open the disc tray. Load the disc(s) and close the disc tray.



- "➡" indicator lights up when the number of tracks is more than 14.
- For loading discs on other trays each, press the **DISC SKIP** button on the unit.
- 8cm(3 inches) CDs can be loaded on the inside circle of the tray, too.

Note

Do not open or close the tray by force.
Doing so may damage it.

3. Press **Play/Pause** button on the unit or the **Play** button on the remote control to start play.

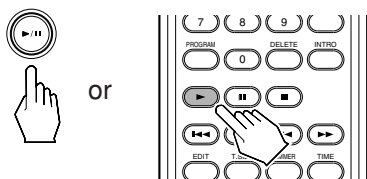

- "▶" indicator lights up.
- The unit plays from the first track on the 1st disc to the last track on the 5th disc.

4. To interrupt play temporarily, press **Play/Pause** button on the unit again or the **Pause** button on the remote control.

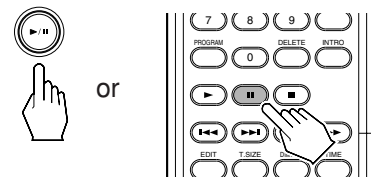

- "||" indicator lights up.
- Press **Play/Pause** button on the unit again or the **Play** button on the remote control to restart play.

5. Press **Stop/Clear** button on the unit or the **Stop/Clear** button on the remote control to stop play.

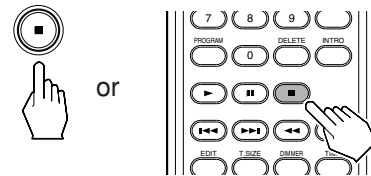

- Display in Stop Mode -

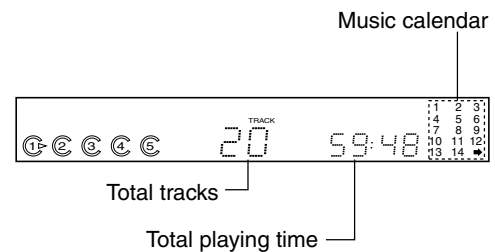

Changing Discs during Play

1. Press the **OPEN/CLOSE** button on the unit to open the disc tray.



2. Change the desired discs.

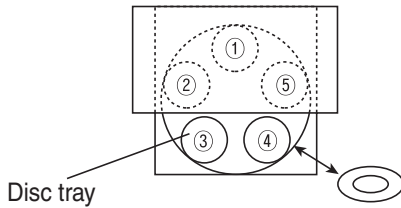

- During playing the disc ①, the discs ③ and ④ can be changed.
- After changing the discs, press the **OPEN/CLOSE** button on the unit to close the disc tray.
- When changing the disc ② or ⑤, press the **DISC SKIP** button on the unit and rotate the disc tray.

Skip and Search Play

❖ Selecting a Disc

- Press the corresponding **Disc selector** button on the unit to start play from the desired disc.
- Press **DISC** button on the remote control first and then the desired disc number(1~5) on the **NUMERIC** buttons within 2 seconds.

(Example) When selecting the disc 3.

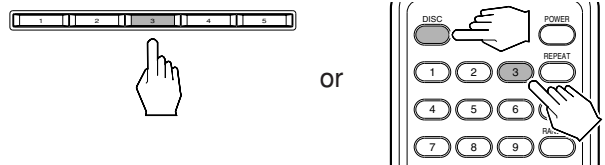

- The first track of selected disc will be played.

❖ Searching for a Passage during Play

- Press and hold down **⏮ / ⏭** buttons on the unit or the **⏮ / ⏭** button on the remote control until the desired passage is reached.

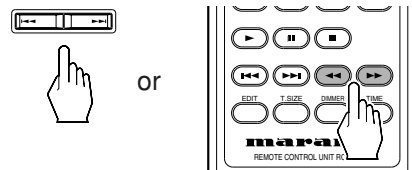

❖ Selecting a Track during Play

- Press **⏮ / ⏭** buttons on the unit or the **⏮ / ⏭** button on the remote control momentarily and repeatedly until the desired track is selected.

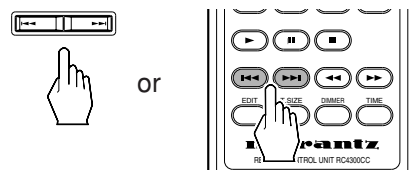

- When using the **NUMERIC** buttons on the remote control.

(Example)

When selecting "9" :

When selecting "22" : → within 2 sec.

Playing Tracks in Random Sequence (Random Play)

❖ 1 Disc Random Play

- Press **RANDOM** button on the unit or the **RANDOM** button on the remote control to play tracks in random sequence.

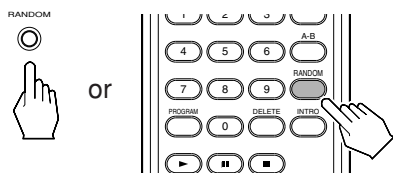

- “RANDOM” indicator lights up.
- The unit automatically selects and plays tracks on the current disc in random sequence.

❖ All Discs Random Play

- In the 1 disc random play mode, press **RANDOM** button again.
- The unit automatically selects a disc among five discs and a track on that disc in random sequence and plays it.
- After that track has been played, the unit continues to select another disc and a track on that disc in random sequence and plays it.
- Press **RANDOM** button again to cancel the random play.
- Each time **RANDOM** button is pressed, the random play mode changes as follows:

→ RANDOM 1 DISC → RANDOM ALL DISCS → OFF

Playing the First 10 Seconds of Each Track (Introscan Play)

❖ 1 Disc Introscan Play

- Press **INTRO** button on the unit or the **INTRO** button on the remote control to play the first 10 seconds of each track.

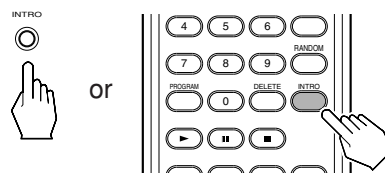

- “INTRO” indicator lights up.
- The unit plays the first 10 seconds of each track from the current disc to the 5th disc.

❖ All Discs Introscan Play

- In the 1 disc introscan play mode, press **INTRO** button again.
- The unit plays the first 10 seconds of each first track from the current disc to the last disc.
- Press **INTRO** button again to cancel the introscan play.
- Each time **INTRO** button is pressed, the introscan play mode changes as follows:

→ INTRO 1 DISC → INTRO ALL DISCS → OFF

Repeat Play

❖ Repeating a Single Track during Play

- Press **REPEAT** button on the unit or the **REPEAT** button on the remote control after selecting the desired track.

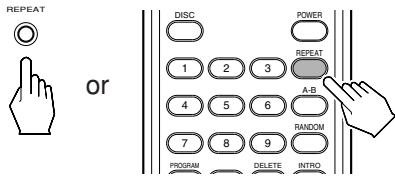

❖ Repeating a Disc during Play

- After selecting the desired disc, press **REPEAT** button again in the 1 track repeat mode.

❖ Repeating a All Discs during Play

- Press **REPEAT** button again in the 1disc repeat mode.
- Each time **REPEAT** button is pressed, the repeat mode changes as follows:



❖ Repeating a Specific Passage during Play

1. At the beginning of the desired passage, press **REPEAT A<->B** button on the remote control.

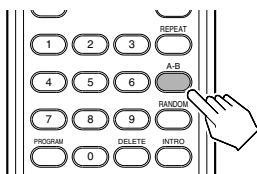

- “REPEAT” indicator lights up and “A<->” indicator is flickering.

2. At the end of the desired passage, press this button again, then “B” indicator lights up and the desired passage is played repeatedly.

- Press **REPEAT** button to cancel the repeat play.

Playing Tracks in Any Sequence (Programmed Play)

Note :

- Up to 32 selections can be programmed to play in any desired sequence.
- The track number greater than 99 can not be memorized.

❖ Programming the Tracks on the CDs

1. In the stop mode, enter the program mode. Press **PROGRAM** button on the unit or the **PROGRAM** button on the remote control.

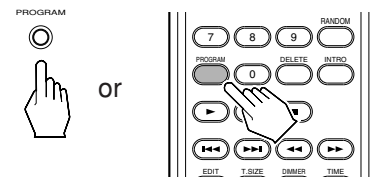

- Display in Program Mode -

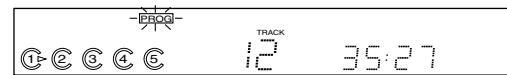

2. Select the desired disc. Press the corresponding **Disc selector** button or **DISC SKIP** button on the unit. Press **DISC** button on the remote control first and then the desired disc number(1~5) on the **NUMERIC** buttons within 2 seconds.

(Example) When selecting the disc 1.

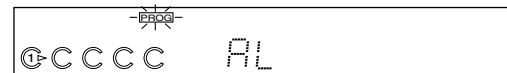
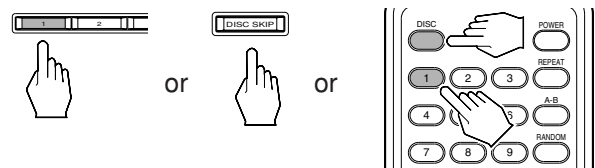

- If the **PROGRAM** button is pressed without selecting a track, the selected disc is programmed as a selection.

- Select the desired track.
Press **◀◀** / **▶▶** buttons on the unit or the **◀◀** / **▶▶** button or the **NUMERIC** buttons on the remote control.

(Example) When selecting the track 4.

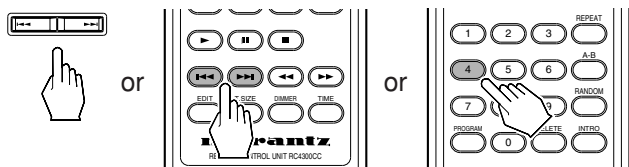

- Store the selected track in the memory. Press **PROGRAM** button on the unit or the **PROGRAM** button on the remote control.

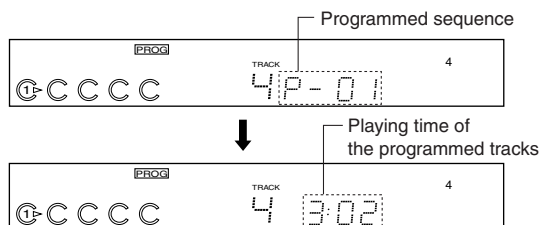

- Because it is impossible to know the playing time of each selection from five discs, “--:--” can appear on the time display.

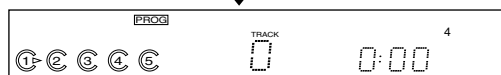

- When selecting a track with the **NUMERIC** buttons, the selected track is stored automatically without pressing the **PROGRAM** button.

- Repeat the above steps **2**, **3** and **4** until the desired program is completed.

- Start the programmed play.
Press **Play/Pause** button on the unit or the **Play** button on the remote control.

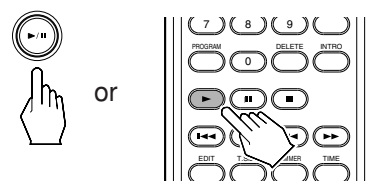

- During the programmed play, when you want normal play without clearing your programmed selections, select the desired disc with the **Disc selector** or **DISC SKIP** button or the desired track on the current disc with the **NUMERIC** buttons, then normal play will start from that disc or that track.
- To return to the program mode (meaning “PROG” lights up in the stop mode), press the **PROGRAM** button in the stop mode.

❖ Checking the Programmed Selections

- Each time the **PROGRAM** button on the unit or the **PROGRAM** button on the remote control is pressed in the program mode (meaning “PROG” lights up in the stop mode), the programmed selections will appear in the programmed sequence.

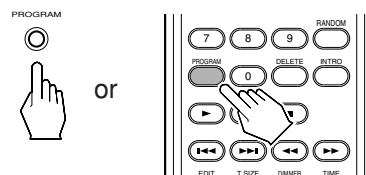

❖ Rectifying Any Wrong Programmed Selection

(Example)

When the track 3, 5 and 7 of the disc 1 are programmed and you want to store the track 7 of the disc 3 instead of the track 5 of the disc 1.

1. Find the track 5 of the disc 1 in program checking by press **PROGRAM** button on the unit or the **PROGRAM** button on the remote control.

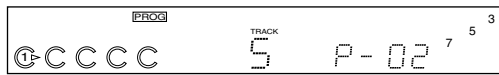

2. Select the disc 3.

Press the **Disc selector** button or **DISC SKIP** button on the unit.

Press **DISC** button on the remote control first and then the disc number 3 on the **NUMERIC** buttons within 2 seconds.

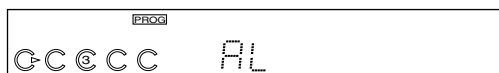
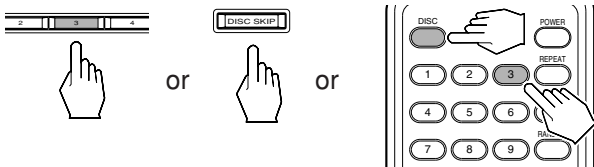

3. Select the track 7.

Press **◀◀ / ▶▶** buttons on the unit or the **◀◀ / ▶▶** button or the **NUMERIC** buttons on the remote control.

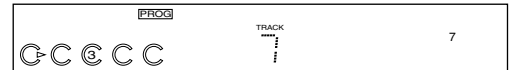
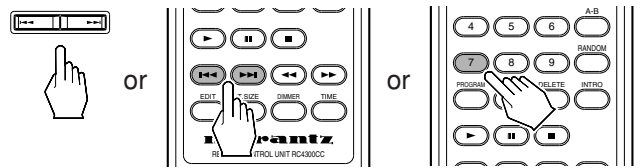

4. Store the selected track in the memory. Press **PROGRAM** button on the unit or the **PROGRAM** button on the remote control.

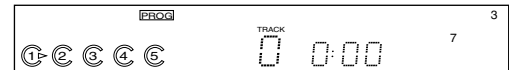
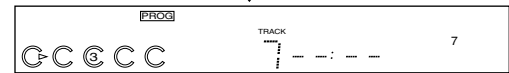
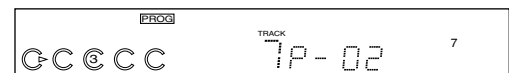

- When selecting a track with the **NUMERIC** buttons, the selected track is stored automatically without the **PROGRAM** button.

❖ Clearing the Programmed Selections

- To Clear One by One

- Each time **Stop/Clear** button on the unit or the **Stop/Clear** button on the remote control is pressed in the program mode, the programmed selections are cleared one by one in the opposite sequence.

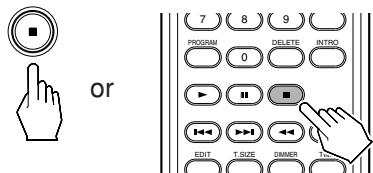

- To Delete a Specific Selection

- Find the desired selection in program checking, and press **Stop/Clear** button to delete.

1. Press **PROGRAM** button on the unit or the **PROGRAM** button on the remote control until the track (or disc) to delete appears on the display.



2. Press **Stop/Clear** button on the unit or the **Stop/Clear** button on the remote control during the track (or disc) to delete is displayed.

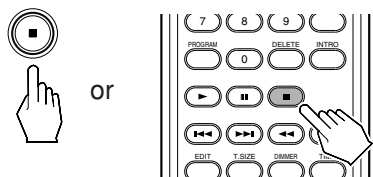

- To Clear All Programmed Selections

- Press **Stop/Clear** button on the unit or the **Stop/Clear** button on the remote control for more than 4 seconds in the program mode.

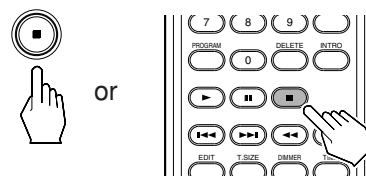

- Opening the disc tray clears all programmed selections, too.



Editing for Recording

Note :

- Up to 30 tracks for auto edit or 32 tracks for manual edit can be edited according to the tape length.
- It is possible only on the current disc.
- Use **Disc selector** or **DISC SKIP** buttons before entering edit mode.

❖ Setting Up Auto Edit

1. In the stop mode, select the auto edit mode. Press **EDIT** button on the unit or the **EDIT** button on the remote control.

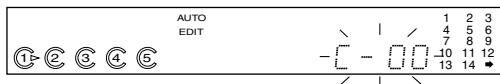
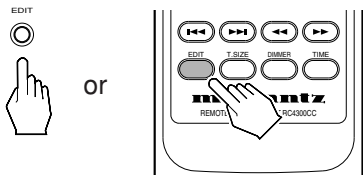

- Each time **EDIT** button is pressed, the edit mode changes as follows:



2. Select the desired tape length. Press **T.SIZE** button on the unit or the **T.SIZE** button on the remote control.

(Example) When the tape length is 46 minutes.

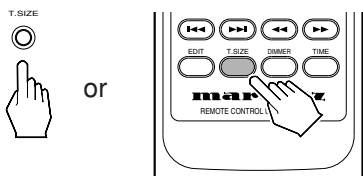

- Each time **T.SIZE** button is pressed, the tape length changes as follows:

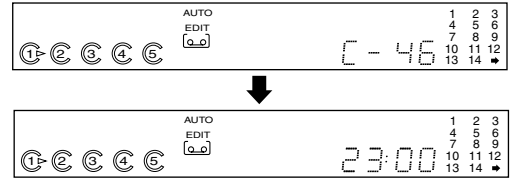
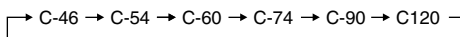

- You can select the tape length at your option with the **NUMERIC** buttons on the remote control.
- By **NUMERIC** buttons, specify tape length of *single way*, although **T.SIZE** stands for tape length of both sides.

(Example)

When the tape length of each side is 23 minutes.

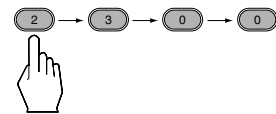

3. Press the **EDIT** button on the unit or the **EDIT** button on the remote control to automatically edit the tracks to be recorded.

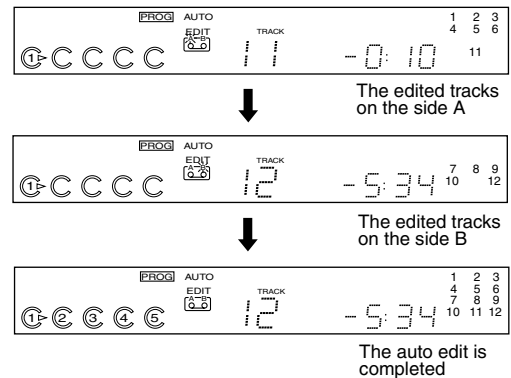
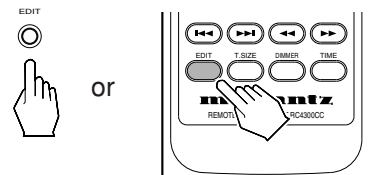

❖ Setting Up Manual Edit

1. In the stop mode, select the manual edit mode. Press **EDIT** button on the unit or the **EDIT** button on the remote control.

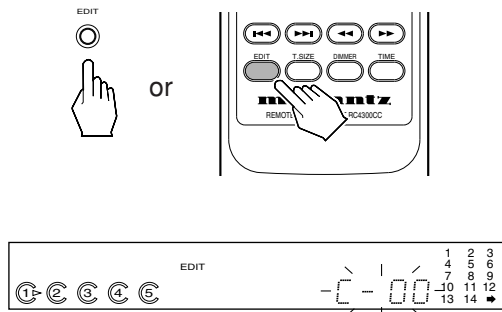

2. Select the tape length as you do in "Making auto edit" procedure.

3. Press **PROGRAM** button on the unit or the **PROGRAM** button on the remote control to manually edit the tracks to be recorded.

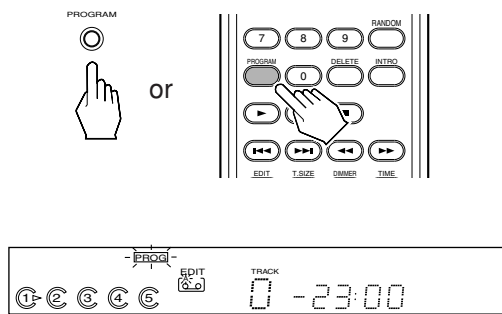

4. Edit the tracks for the side A repeating steps 3 and 4 in "Playing Tracks in Any Sequence (Programmed Play)" procedure on page 15.

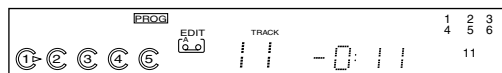

Note :

- During manual edit, if the "-" indicator in the time display disappears and "➡" flickers, it means that the total time of the edited tracks exceeds the tape length. So you should edit again.
- When a track with a number greater than 30 is edited, the time display may show "- : - : -".
- Manual edit is only available on the current disc. If you press **Disc selector** or **DISC SKIP** buttons, the unit exits from edit mode.

5. Press **EDIT** button on the unit or the **EDIT** button on the remote control to start editing for the side B.

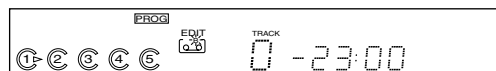
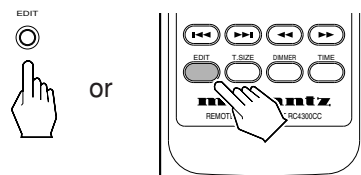

6. Do the above step 4 to edit the tracks for the side B.
 - If the **PLAY** button is pressed after editing the tracks, play starts from the first track of the side A for recording.
 - If all tracks of the side A have been played, press the **PLAY** button to start play from the first track of the side B for recording.

❖ Checking the Edited Tracks

- In the edit mode, check as you do the programmed tracks. (refer to “Checking the Programmed Selections” on page 15)

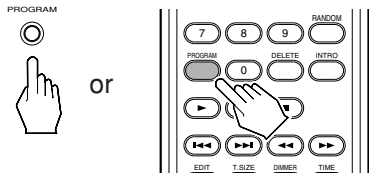

❖ Clearing All Edited Tracks

- In the edit mode, press the **Stop/Clear** button on the unit or the **Stop/Clear** button on the remote control for more than 4 seconds.

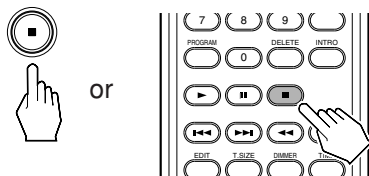

- Opening the disc tray clears all edited tracks, too.



- In the manual edit mode only, you can clear or rectify the edited tracks as you do in “Rectifying Any Wrong Programmed Selection” or “Clearing the Programmed Selections” on page 16 and 17.

❖ Start Edit Recording

Before start editing, connect remote control input of Marantz cassette deck with remote control output of CC4300 by remote control cable.

Reverse mode switch may be set to any of one side (⇐), both sides (⇔) and continuous play (↻).

- **Synchro recording with Marantz auto reverse cassette deck (when set to both sides (⇔) or continuous play (↻) mode).**

1. After setting up Edit program automatically or manually, setup the cassette deck to rec pause state.

2. Press **Play/Pause** button of the unit to start A side program. The player sends out signal to start recording and start playing A side program after 4 seconds.



3. After A side program complete, player turns to the pause state at the beginning of B side program.

4. When A side of the tape ends up, cassette deck inverts its recording direction and set to rec pause state automatically.

5. Press **Play/Pause** button of the unit manually to start B side recording. Player sends out signal to restart recording and start playing B side program after 4 seconds.



6. After B side program complete, player stops playing and clears edit program automatically.

- If the tape ends up before edit program of one side completes, for example by wrong tape length have chosen, cassette deck send out signal to player to let the player cancel the rest of program. Player jumps to the beginning of B side if it was A side or stop playing and clear edit program if it was B side.

- **Synchro recording with Marantz one-way cassette deck, or Marantz auto reverse cassette deck set to one side (↔) mode.**

1. After setting up Edit program automatically or manually, setup the cassette deck to rec pause state.

2. Press **Play/Pause** button of the unit to start A side program. The player sends out signal to start recording and starts playing A side program after 4 seconds.



3. After A side program complete, player turns to the pause state at the beginning of B side program.

4. When A side of the tape ends up, Reverse cassette tape or invert recording direction manually and set to rec pause state.

5. Press **Play/Pause** button of the unit manually to start B side recording. Player sends out signal to restart recording and starts playing B side program after 4 seconds.



6. After B side program complete, player stops playing and clears edit program automatically.

- **Recording with Marantz cassette deck without remote cable connection, and recording with the cassette deck other than Marantz.**

1. After setting up Edit program automatically or manually, start recording of cassette deck first.

2. Press **Play/Pause** button of the unit to start A side program. Then player starts playing A side program after 4 seconds.



3. After A side program complete, player turns to the pause state at the beginning of B side program.

4. When A side of the tape ends up, Reverse cassette tape or invert recording direction manually and start recording.

5. Press **Play/Pause** button of the unit to start B side recording. Then player starts playing B side program after 4 seconds.



6. After B side program complete, player stops playing and clears edit program automatically.

Deleted Play

When there are the undesired discs or tracks, you can delete up to 32 selections.

❖ Deleting the Undesired Discs or Tracks

1. In the stop mode, enter the delete mode. Press **DELETE** button on the unit or the **DELETE** button on the remote control.

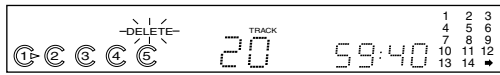
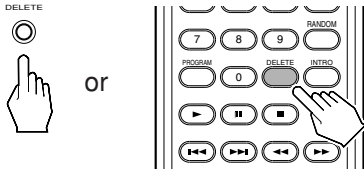

2. Select the undesired disc.
Press the corresponding **Disc selector** button or **DISC SKIP** button on the unit.
Press **DISC** button on the remote control first and then the desired disc number(1~5) on the **NUMERIC** buttons within 2 seconds.

(Example) When selecting the disc 1.

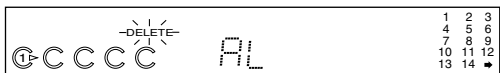
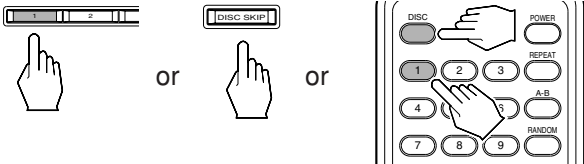

- If the **DELETE** button is pressed without selecting a track, the selected disc is deleted as a selection.

3. Select the undesired track.
Press **◀◀ / ▶▶** on the unit or the **◀◀ / ▶▶** button or the **NUMERIC** buttons on the remote control.

(Example) When selecting the track 4.

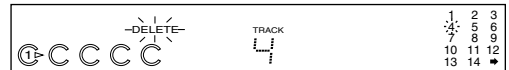
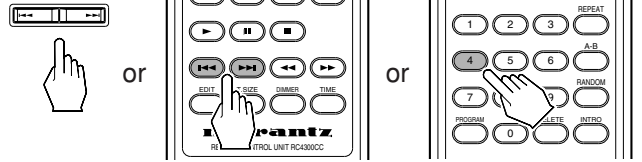

4. Delete the selected track. Press **DELETE** button on the unit or the **DELETE** button on the remote control.

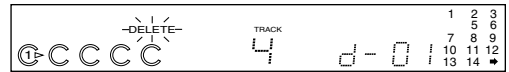
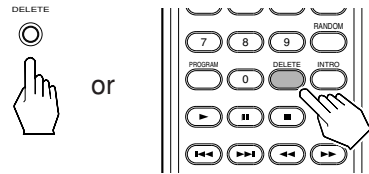

- When selecting a track with the **NUMERIC** buttons, the selected track is deleted automatically without pressing the **DELETE** button.

5. When deleting other tracks on that disc within 8 seconds after the above step 4, repeat the above steps 3 and 4 and when deleting the tracks on other discs, repeat the above steps 2, 3 and 4.

6. Start the deleted play.
Press **Play/Pause** button on the unit or the **Play** button on the remote control.



❖ Checking the Deleted Selections

- Each time the **DELETE** button on the unit or the **DELETE** button on the remote control is pressed in the delete mode (meaning “DELETE” lights up in the stop mode), the deleted selections will appear in the deleted sequence.

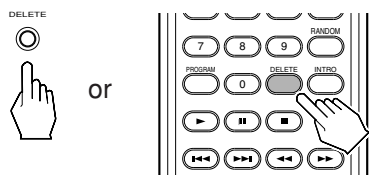

❖ Recovering the Deleted Selections

- To Recover One by One

- Each time **Stop/Clear** button on the unit or the **Stop/Clear** button on the remote control is pressed in the delete mode, the deleted selections are recovered one by one in the opposite sequence.

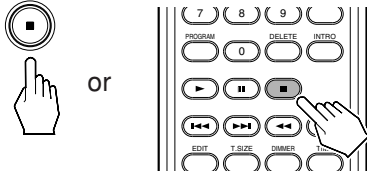

- To Recover a Specific Selection

- Find the desired track in delete selection checking and press **Stop/Clear** button to recover.

1. Press **DELETE** button on the unit or the **DELETE** button on the remote control until the track (or disc) to recover appears.

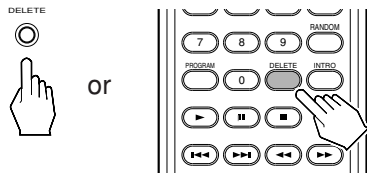

2. Press **Stop/Clear** button on the unit or the **Stop/Clear** button on the remote control during the track (or disc) to recover is displayed.

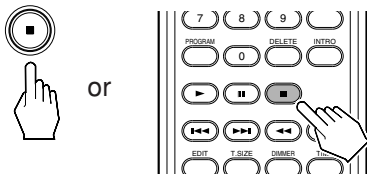

- To Recover All Deleted Selections

- Press **Stop/Clear** button on the unit or the **Stop/Clear** button on the remote control for more than 4 seconds in the delete mode.

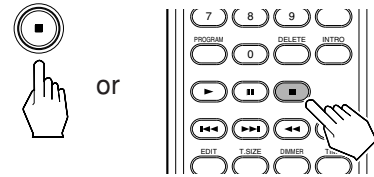

- Opening the disc tray recovers all deleted selections, too.



Selecting a Brightness of the Display

- Each time **DIMMER** button on the remote control is pressed, the brightness of the display changes as follows;

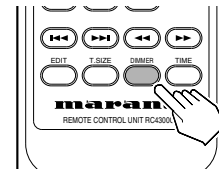
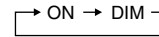

Selecting a Time Display

- Each time **TIME** button is pressed during play, time display changes as follows:

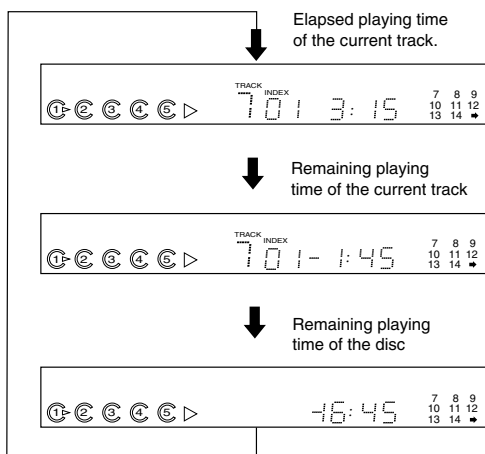
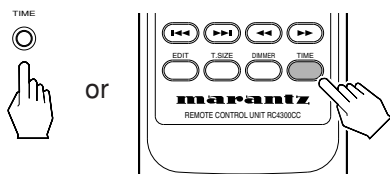

- During random or programmed play, etc., the remaining playing time of the disc may show "-- : --".
- When a track of which number is greater than 30 is programmed, edited or being played, the time display may show "-- : --".

Using the Headphones

- For private listening, insert a plug of the headphone into "PHONES" jack.

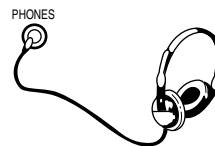

External Control (Serial Interface) RS-232C

The unit can receive external control signals and transmit status information by connecting a cross cable on the market to the D-sub 9 pin connector for RS-232C external control.

❖ Pin Assignment of the Connector

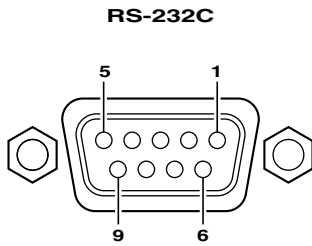

1	NC
2	RX
3	TX
4	NC
5	GND
6	NC
7	NC
8	NC
9	NC

❖ RS-232C Physical Specification

Cable	Straight-type
Connector	D-Sub 9 pin (Female type)
Baud rate	9600bps
Data bits	8 bits
Parity	None
Stop bit	1 bit
Flow control	None

❖ Data Packet

A packet contains data from 5 to 8 bytes in length. In serial communication, ASCII code from 00h to 7fh is used. So the HEX data are converted into ASCII code and set to the data packet. The data packet includes CR code (0dh) at the end.

Example 1: CD Play (Code: 20 53)

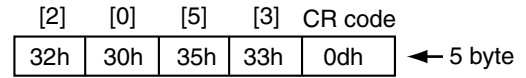

Example 2: T.SIZE (Code 20 104 08)

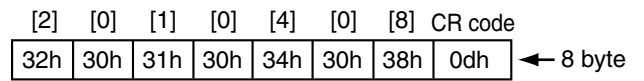

The unit can identify following commands on next page.

- **Remote Control Unit (RC4300CC) RC-5 Code**

The unit can be controlled through its infrared IR sensor on the front panel when it receives remote control signals that supports RC-5 signals as shown in the table on the following.

These remote control (RC-5) codes can also be used if sent through the RS232C port found on the rear panel of the unit.

Key No.	Function	Code	ASCII Code
1	POWER ON/STANDBY	20 12	32h 30h 31h 32h 0dh
2	DISC	20 30	32h 30h 33h 30h 0dh
3	1	20 01	32h 30h 30h 31h 0dh
4	2	20 02	32h 30h 30h 32h 0dh
5	3	20 03	32h 30h 30h 33h 0dh
6	4	20 04	32h 30h 30h 34h 0dh
7	5	20 05	32h 30h 30h 35h 0dh
8	6	20 06	32h 30h 30h 36h 0dh
9	7	20 07	32h 30h 30h 37h 0dh
10	8	20 08	32h 30h 30h 38h 0dh
11	9	20 09	32h 30h 30h 39h 0dh
12	0	20 00	32h 30h 30h 30h 0dh
13	REPEAT (1/ALL)	20 29	32h 30h 32h 39h 0dh
14	A-B (A<->B)	20 59	32h 30h 35h 39h 0dh
15	RANDOM	20 28	32h 30h 32h 38h 0dh
16	PROGRAM (PROG/REV)	20 36	32h 30h 33h 36h 0dh
17	DELETE (DEL/REV)	20 49	32h 30h 34h 39h 0dh
18	INTRO	20 43	32h 30h 34h 33h 0dh
19	PLAY ►	20 53	32h 30h 35h 33h 0dh
20	PAUSE ■■	20 48	32h 30h 34h 38h 0dh
21	STOP ■	20 54	32h 30h 35h 34h 0dh
22	PREVIOUS (SKIP) ◀◀	20 33	32h 30h 33h 33h 0dh
23	NEXT (SKIP) ▶▶	20 32	32h 30h 33h 32h 0dh
24	REW (SEARCH) ◀◀	20 50	32h 30h 35h 30h 0dh
25	FF (SEARCH) ▶▶	20 52	32h 30h 35h 32h 0dh
26	EDIT	20 104	32h 30h 31h 30h 44h 0dh
27	T.SIZE	20 104 08	32h 30h 31h 30h 44h 30h 38h 0dh
28	DIMMER (DISPLAY)	20 71	32h 30h 37h 31h 0dh
29	TIME	20 11	32h 30h 31h 31h 0dh

- **Acceptable RC-5 Code**

These RC-5 codes are not supported by remote control unit (RC4300CC), but they can also be used if sent through the RS232C port found on the rear panel of the unit.

Key No.	Function	Code	ASCII Code
a	POWER ON	20 12 01	32h 30h 31h 32h 30h 31h 0dh
b	STANDBY	20 12 02	32h 30h 31h 32h 30h 32h 0dh
c	DISC 1	20 55	32h 30h 35h 35h 0dh
d	DISC 2	20 56	32h 30h 35h 36h 0dh
e	DISC 3	20 57	32h 30h 35h 37h 0dh
f	DISC 4	20 64	32h 30h 36h 34h 0dh
g	DISC 5	20 65	32h 30h 36h 35h 0dh

Troubleshooting

If your unit should not perform as expected, consult the table below to see if the problem can be corrected before seeking help from your dealer or our service organization.

Problem	Possible Cause	REMEDY
No power	<ul style="list-style-type: none"> The AC input cord is disconnected. The POWER switch is not pressed correctly. 	<ul style="list-style-type: none"> Connect the cord securely. Press the POWER button to ON.
No play	<ul style="list-style-type: none"> The disc is loaded upside down. Dirty disc. Defective or deeply scratched disc. 	<ul style="list-style-type: none"> Reload the disc with the printed side up. Clean the disc. Load another disc.
No sound	<ul style="list-style-type: none"> Incorrect connections. Incorrect operation of the amplifier. The "II" indicator lights up. 	<ul style="list-style-type: none"> Make connections correctly. Operate the amplifier correctly. Press the PLAY or PAUSE button to cancel the pause mode.
Poor or distorted sound	<ul style="list-style-type: none"> The unit is connected to the PHONO input jacks of the amplifier. Poor connections. 	<ul style="list-style-type: none"> Make connections correctly. Check the connections and connect all cords securely.
Sound skips	<ul style="list-style-type: none"> Defective or deeply scratched disc. This unit is placed on a surface that is subject to vibration or physical shock. 	<ul style="list-style-type: none"> Play another disc. Place this unit on a stable surface.
Programming or deleting does not perform.	<ul style="list-style-type: none"> The disc is dirty or badly scratched. The programming or deleting procedure is not correct. The number of the programmed selections is 32. 	<ul style="list-style-type: none"> Try again with a scratch-free disc. Try again. Check the number of the programmed selections.
"Error" is displayed.	<ul style="list-style-type: none"> Incorrect operation. 	<ul style="list-style-type: none"> Press the OPEN/CLOSE button to open and close the disc tray or press the POWER switch to turn the power off and on.

Specifications

SYSTEM Compact Disc Digital Audio

TYPICAL AUDIO PERFORMANCES

Number of channels 2
Frequency response, 20~20,000 Hz ± 0.5 dB
Signal to noise ratio, A Wtd. 110 dB
Dynamic range 95 dB
Total harmonic distortion, 1 kHz 0.005 %
Wow and flutter Quartz crystal precision
Audio output level 2 V RMS
Digital output
Optical, wavelength 660 nm $-15 \sim -20$ dBm

OPTICAL READOUT SYSTEM

Laser Semiconductor AlGaAs
Wavelength 760~800 nm
Numerical aperture 0.45

SIGNAL FORMAT

Sampling Frequency 44.1 kHz
D/A Conversion 1 bit P.L.M. D/A Conversion
Oversampling 8 times

GENERAL

Power supply 120 V, 60 Hz
Power consumption 12 W
Dimensions (W x H x D) 440 x 113 x 393 mm(17-5/16 x 4-7/16 x 15-1/2 inches)
Weight (NET) 5.8 kg(12.8 lbs)

Note : Design and specifications are subject to change without notice for improvements.

COUNTRY	COMPANY	ADDRESS
ALGERIE	Azur 2000	8, Lotissement Ben Hatadi, Alger, Algeria
ARMENIA	NGYIG Ltd.	47 A/75 St. Lalaiaants, 375000 Yerevan, Armenia
AUSTRALIA	Jamo Australia Pty. Ltd.,	24 Lionel Road, Mt. Waverley, VIC 3149, Australia
AUSTRIA	Huber & Prohaska GmbH	Taborstraße 95 / Ladestraße 1, Gebäude Hangartner, A-1200 Wien, Austria
BAHREIN	Ambassador Stores	P.O. Box 237,141, Government Avenue, Manama,Bahrein
BANGLADESH	Target	1078, Ramjoy Mohanja Lane Asadgonj, Chittagong 4000, Bangladesh
BELGIUM	Van der Heyden Audio N.V.	Brusselbaan 278, 9320 Erembodegem, Belgium
BULGARIA	Ariescommerce GmbH	Makedonia Blvd. 16, 1606 Sofia, Bulgaria
CANADA	Lenbrook Industries Limited	633 Granite Court, Pickering, Ontario
CHINA	Guang Chang Audio International Co., Ltd.	No.38 Yushan Road, ShiQiao, Pan Yu, Guang Dong, China
CYPRUS	Empire Hifi systems Ltd.	P.O. Box 5604, Nicosia, Cyprus
CZECH REPUBLIC	Audio International	Sokolska 41, 67902 Rajecsko, OKR,Blansko, Czech Republic
DENMARK	Audio Nord	Dali Allé 1, 9610 Noerager, Denmark
DUBAI	V.V.& SONS	P.O. Box 105, Dubai, U.A.E.
EGYPT	Solimco	9, El Attibaa St. Doki, Cairo, Egypt
ESTONIA	HiFi Club Estonia	Ehte 4, 90503 Haapsalu, Estonia
F.Y.R.O.M.	T.P. KODI	ul.Cedomir Kantargiev 21a, Skopje, Former Yugoslavian Republic of Macedonia
FINLAND	Audio Nord	Uudenmaankatu 4-6, Helsinki SF-00120, Finland
FRANCE	Marantz France	A division of Marantz Europe B.V., P.O. Box 301, 92 156 Suresnes Cedex, France
GERMANY	Marantz Deutschland	Hakenbusch 3, 49078 Osnabrück, Germany
GREECE	Adamco S.A.	188, Hippocratous Street, 11471 Athens, Greece
HEADQUARTERS EUROPE:	Marantz Europe B.V.	P.O. Box 8744, 5605 LS Eindhoven, The Netherlands
HONG KONG	Marantz Asia Ltd.	Unit 1706, Metroplaza II, 223 Hing Fong Road, Kwai Fong, N.T., Kowloon, Hong Kong
HUNGARY	Infovox Ltd.	Terez Krt.31, 1067 Budapest, Hungary
ICELAND	ID Electronics Ltd.	Armula 38, 108 Reykjavik, Iceland
INDIA	NOVA Audio Private	8,Punam Co-op.Society 29/30 Road#5, Union Park MUMBAI 400052, India
IRAN	Home Co.	5th floor no 878 Philips Building Enghelab ave, P.O. 11365/7844 Tehran, Iran
IRELAND	Marantz Ireland	Clonskeagh, Dublin 14, Ireland
ISRAEL	Elmor Ltd.	52 Heh Beiyar Street, Kikar Hamedina, Tel Aviv, Israel
ITALY	Marantz Italy	Via Casati 23, 20052 Monza (Milano), Italy, Servizio Consumatori 1678-20026, Numero Verde
IVORY COAST	Hifivoir	B.P. 2428, Abidjan 01, Ivory Coast
JAPAN	Marantz Japan Inc.	35-1 Sagami Ohno 7-Chome, Sagamihara-shi, Kanagawa 228-8505, Japan
KOREA	Mk Enterprises Ltd.	121-210, 2F Shinhan Bldg., 247-17 Seokyo-dong, Mapo-ku, Seoul, Korea
KUWAIT	alAlamiah Electronics Intl.	P.O. Box 8196, Salmiah 22052, Kuwait
LATVIA	Ace Ltd.	61, LacPlesa Str., Riga LV 1011, Latvia
LEBANON	AZ Electronics S.A., 1,	P.O. Box 11 2833, Beirut, Lebanon
LITHUANIA	Accapella Ltd.	Ausros, Vartu G/5, Pasazo SKG., 2001 Vilnius, Lithuania
MALAYSIA	Wo Kee Hong Electronics Sdn. Bhd.	Suite 8.1, Level 8, Menara Genesis, No. 33, Jalan Sultan Ismail, 50250 Kuala Lumpur, Malaysia
MALTA	Doneo Co Ltd.	78 The Strand, Sliema SLM07, Malta
MAURITIUS	SKR Electronics Ltd.	P.O. Box 685, Bell Village, Port Louis, Mauritius
MILITARY MARKET EUROPE	PASCO GmbH	PO BOX 1280, Sandhausen 69200, Germany
NETHERLANDS	Marantz Domestic Sales	A division of Marantz Europe B.V., Building SFF2, P.O. Box 80002, 5600 JB Eindhoven, The Netherlands
NEW ZEALAND	Wildash Audio Systems	14 Maivern Road, Mt. Albert, Auckland, New Zealand
NORWAY	Audio Nord	Sandkerveien 64, Oslo 0483, Norway
OMAN	Mustafa & Jawad Trading CO.	P.O. Box 1918, Ruwi, Oman
POLAND	Philips Polska Sp. z.o.o.	Al.Jerozolimskie 195b, 02 222 Warszawa, Poland
PORTUGAL	Corel2	Comércio de Electrónica Lda., Av. Luís Bivar, No 85 A, 1050 Lisboa, Portugal
PROFESSIONAL EUROPE	Marantz Professional Products	Kingsbridge House, Padbury Oaks, 575-583 Bath Road, Longford, Middlesex UB7 0EH, U.K.
PROFESSIONAL U.S.A.	Marantz Professional Products	Distributed by: Superscope Technologies Inc., 1000 Corporate Blvd. Ste.D, Aurora, Illino
QATAR	Almana & Partners W.W.L.	P.O. Box 49, Doha, Qatar
REUNION	Vision +	180 Rue du Marechal Leclerc, 97400 Saint Denis, Ile de la Reunion
ROMANIA	Nova Music Entertainment	5, Zagazului Str. Bl.1G,apt.18, sector 1,Bucharest, Romania
RUSSIA	Absolute Audio	7/2, Montazhnaya Street, 107497 Moscow, Russia
SAUDI ARABIA	Adawlia Univ. Electr. Apl	P.O. Box 2154, Alkhobar 31952, Saudi Arabia
SINGAPORE	Wo Kee Hong Distribution PTE Ltd.	130 Joo Seng Road, #03-02 Olivine Building, Singapore 368357
SLOVAKIA	Bis Audio s.r.o.	Nam. SNP 10, 96001 Zvolem, Slovakia
SLOVENIA	Bofex	Smartinska 152, HALA V/3, 61000 Ljubljana, Slovenia
SOUTH AFRICA	Coherent Imports (PTY) Ltd.	P.O. Box 1614, Alberton, 1450, South Africa
SPAIN	Marantz Spain	Martinez Villergas 2, Apartado 2065, Madrid 28027, Spain
SRI LANKA	The listening Room	Mezzanine Floor, The Landmark 385, Galle Road, Colombo - 3, Sri Lanka
SWEDEN	Audio Nord	Almedalsvagen 4, Gotenborg 402-23, Sweden
SWITZERLAND	Sound Company AG	Postfach, 8010 Zürich, Switzerland
SYRIA	Hamzeh & Partners	Hafez Ibrahim Str. No 117, Damascus Shalan, Syria
TAHITI	Covecolor	Av. Prince Hinoi, Cours de l'union sacré, P.O. Box 2334, Papeete, Tahiti
TAIWAN	Pai-Yuing Co. Ltd.	6th No 148 Sung Kiang Road, Taipei 10429, Taiwan R.O.C.
THAILAND	MRZ Standard Co. Ltd.	746-750 Mahachai Road, Wangburapa, Bangkok 10200, Thailand
TUNESIA	Societe EDEVIG	40, Avenue du Golfe Arabe, El Menzah, 1004, Tunesia
TURKEY	Türk Philips Ticaret A.S.	Yukari Dudullu Organize sanayi Bolgesi, 2.Cadde no.28, 81260 Umraniye-Istanbul, Turkey
U.K.	Marantz Hifi UK Ltd.	Kingsbridge House, Padbury Oaks, 575-583 Bath Road, Longford, Middlesex UB7 0EH, U.K.
U.S.A.	Marantz America Inc.	1100 Maplewood Drive Itasca, IL 60143, U.S.A.
YUGOSLAVIA	ITM Company	Omladinskih Brigada 86, 11070 Belgrade, Yugoslavia
EXPORT	Marantz Domestic Sales	P.O. Box 8744, 5605 LS Eindhoven, The Netherlands

WWW.MARANTZ.COM

marantz® is a registered trademark.

